

SMD Power Inductor CDRH2D16/LD

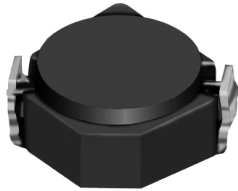

Halogen Free



Description

- Ferrite drum core construction.
- Magnetically shielded.
- L × W × H: 3.2 × 3.2 × 1.8mm Max.
- Product weight: 60mg(Ref.)
- Moisture Sensitivity Level: 1
- RoHS compliance.
- Halogen Free available.

Environmental Data

- Operating temperature range: -40°C~+100°C (including coil's self temperature rise)
- Storage temperature range: -40°C~+100°C
- Solder reflow temperature: 260 °C peak.

Packaging

- Carrier tape and reel packaging
- 7.0" diameter reel
- 1000pcs per reel

Applications

- Ideally used in Mobilephone, PDA, MP3, DSC/DVC, etc. as DC-DC converter inductors.

Dimension - [mm]

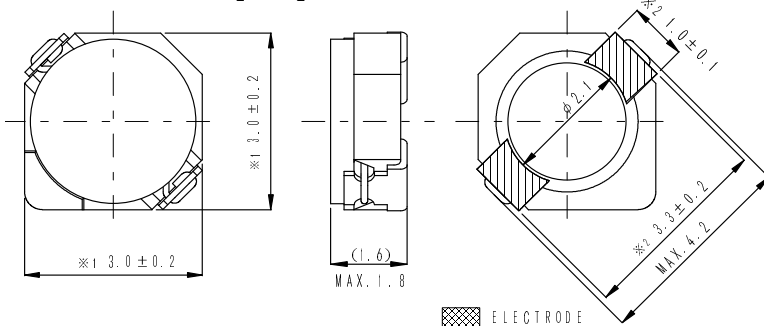

Land pattern and Schematics - [mm]

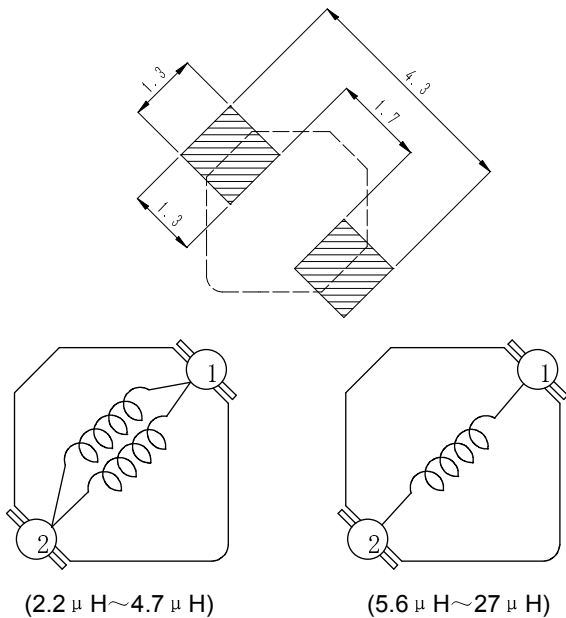

SMD Power Inductor CDRH2D16/LD



Electrical Characteristics

Part Name	Stamp	Inductance (μ H) [within] ※1	D.C.R. (m Ω) Max. (Typ.) (at 20°C)	Saturation Current (A) ※2		Temperature Rise Current (A) ※3
				at 20°C	at 100°C	
CDRH2D16LDNP-2R2NC	A	2.2 \pm 30%	47(38)	0.86	0.65	2.20
CDRH2D16LDNP-2R7NC	B	2.7 \pm 30%	61(49)	0.82	0.60	1.90
CDRH2D16LDNP-3R3NC	C	3.3 \pm 30%	67(54)	0.72	0.52	1.74
CDRH2D16LDNP-3R9NC	D	3.9 \pm 30%	75(60)	0.70	0.48	1.60
CDRH2D16LDNP-4R7NC	E	4.7 \pm 30%	101(81)	0.62	0.45	1.32
CDRH2D16LDNP-5R6NC	F	5.6 \pm 30%	123(98)	0.57	0.40	1.25
CDRH2D16LDNP-6R8NC	G	6.8 \pm 30%	158(127)	0.50	0.35	1.00
CDRH2D16LDNP-8R2NC	H	8.2 \pm 30%	171(137)	0.45	0.33	0.95
CDRH2D16LDNP-100NC	I	10.0 \pm 30%	195(156)	0.42	0.30	0.92
CDRH2D16LDNP-120NC	J	12.0 \pm 30%	223(179)	0.39	0.28	0.85
CDRH2D16LDNP-150NC	K	15.0 \pm 30%	248(198)	0.35	0.26	0.81
CDRH2D16LDNP-180NC	L	18.0 \pm 30%	316(252)	0.32	0.23	0.73
CDRH2D16LDNP-220NC	M	22.0 \pm 30%	418(335)	0.28	0.21	0.60
CDRH2D16LDNP-270NC	N	27.0 \pm 30%	466(373)	0.26	0.18	0.53

※1 Inductance measuring condition: at 100 kHz.

※2 Saturation current: The DC current at which the inductance decreases to 65% of its nominal value.

※3 Temperature rise current: The DC current at which the temperature rise is $\Delta T = 40^\circ\text{C}$. ($T_a = 20^\circ\text{C}$)

SMD Power Inductor CDRH2D16/LD



Saturation Current & Temperature Rise Graph

— L (20°C) — L (100°C) — ΔT

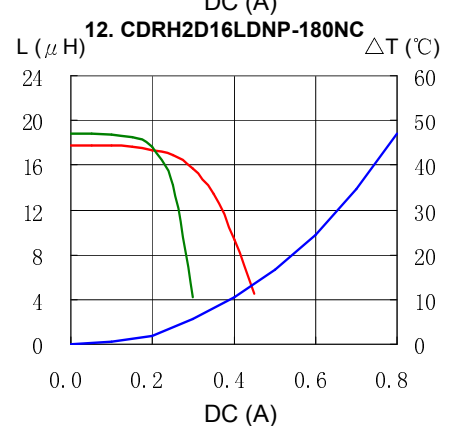
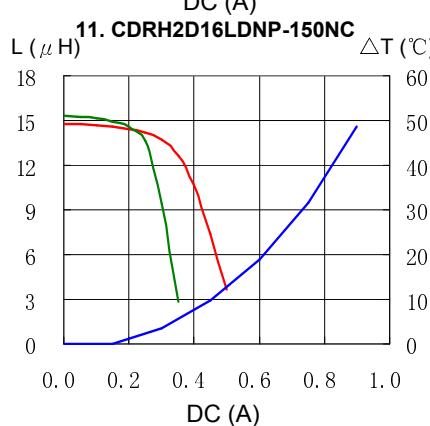
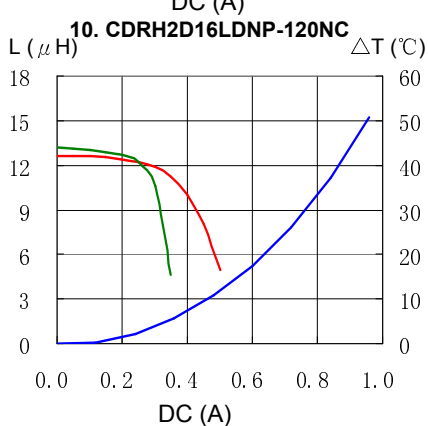
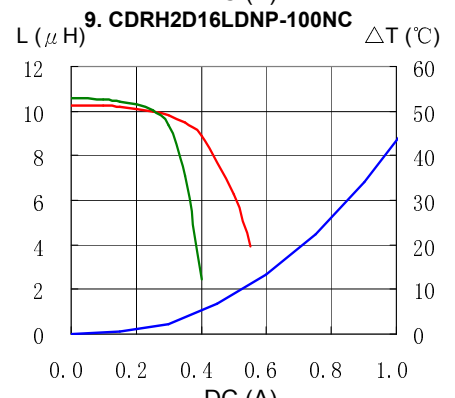
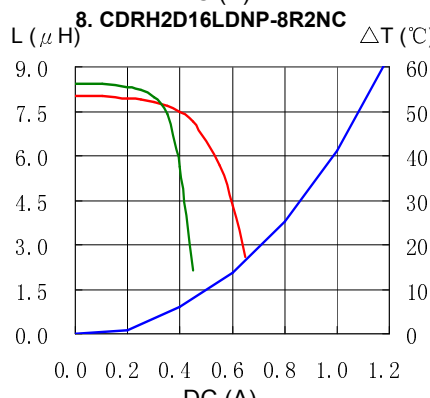
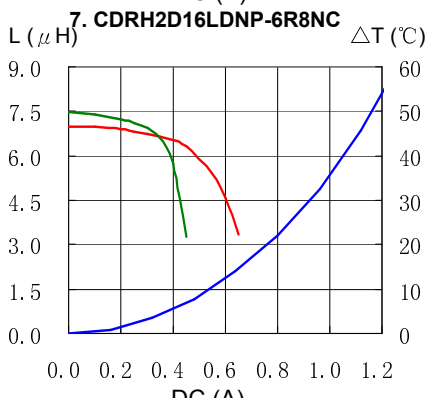
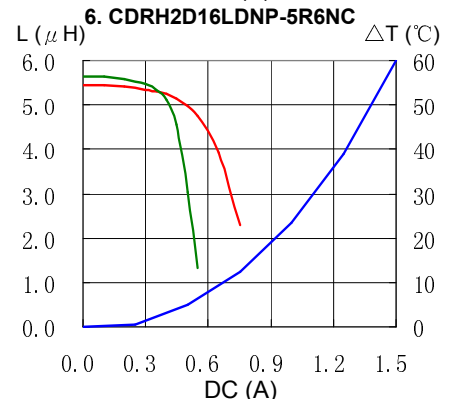
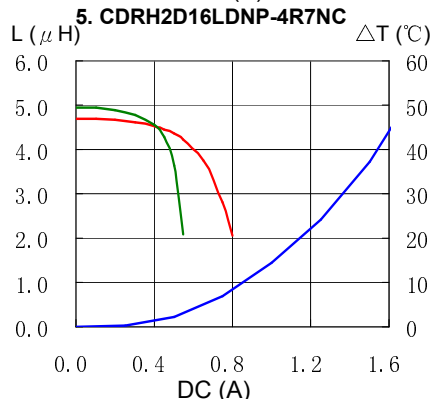
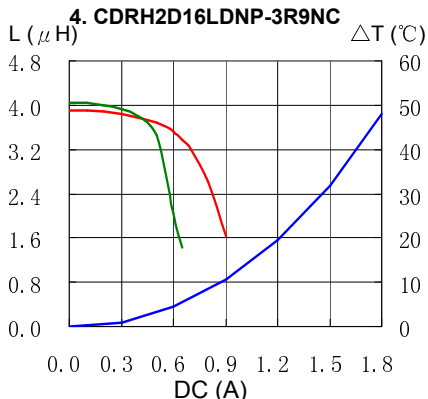
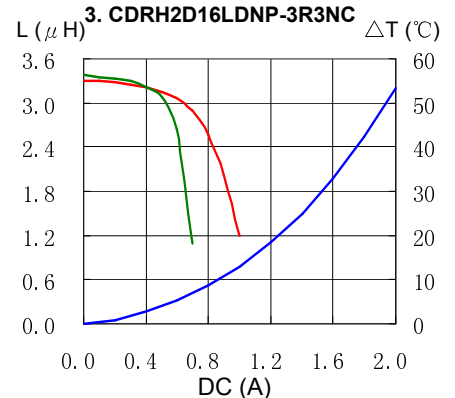
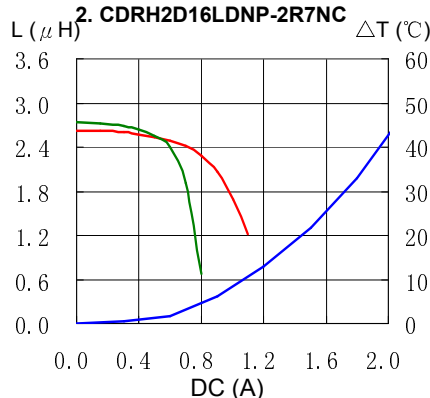
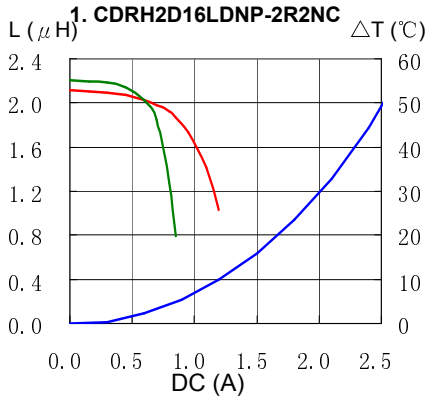

SMD Power Inductor CDRH2D16/LD



Saturation Current & Temperature Rise Graph

— L (20°C) — L (100°C) — ΔT

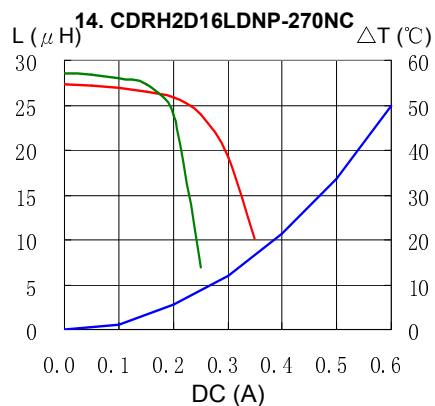
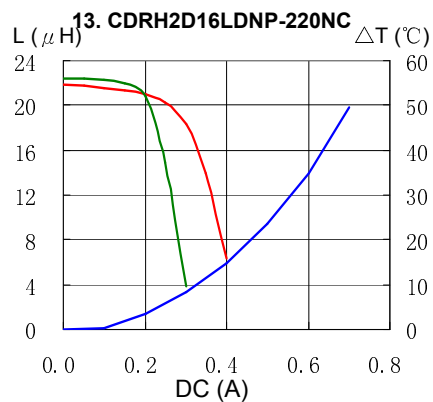

Solder Reflow Condition

