

SMD Power Inductor CDRH125

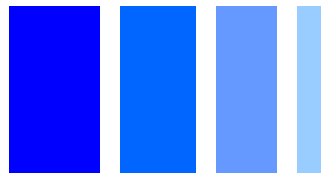

Description

- Ferrite drum core construction.
- Magnetically shielded.
- L × W × H: 12.3 × 12.3 × 6.0 mm Max.
- Product weight: 2.9g(Ref.)
- Moisture Sensitivity Level: 1
- RoHS compliance.

Environmental Data

- Operating temperature range: -40°C ~ +100°C (including coil's self temperature rise)
- Storage temperature range: -40°C ~ +100°C
- Solder reflow temperature: 260 °C peak.

Packaging

- Carrier tape and reel packaging
- 13" diameter reel
- 500pcs per reel

Applications

- Ideally used in Notebook PC, LCD TV, DVD, Game machine, STB, Projector etc. as DC-DC converter inductors.

Dimension - [mm]

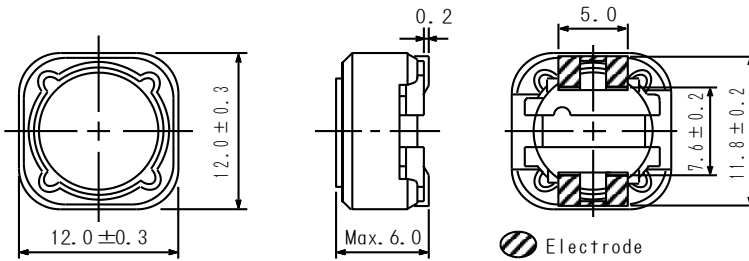

Land pattern and Schematics - [mm]

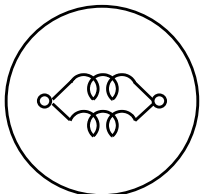
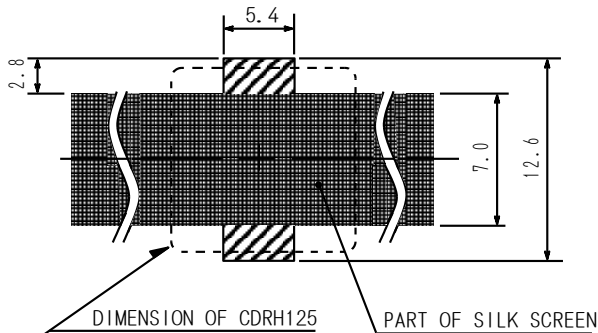

1.3μH ~ 47μH

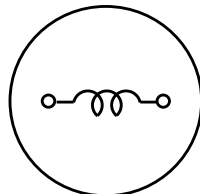

56μH ~ 1mH

SMD Power Inductor

CDRH125

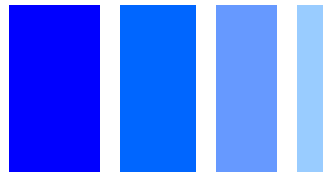

Electrical Characteristics

Part Name	Stamp	Inductance (μH) [within] ※1	D.C.R.(Ω) Max. (Typ.) (at 20°C)	Rated Current (A) ※2
CDRH125NP-1R3NC	1R3	1.3 $\begin{matrix} +30\% \\ -20\% \end{matrix}$	0.012(0.009)	8.00
CDRH125NP-2R1NC	2R1	2.1 $\begin{matrix} +30\% \\ -20\% \end{matrix}$	0.014(0.011)	7.00
CDRH125NP-3R1NC	3R1	3.1 $\begin{matrix} +30\% \\ -20\% \end{matrix}$	0.017(0.013)	6.00
CDRH125NP-4R4NC	4R4	4.4 $\begin{matrix} +30\% \\ -20\% \end{matrix}$	0.020(0.016)	5.00
CDRH125NP-5R8NC	5R8	5.8 $\begin{matrix} +30\% \\ -20\% \end{matrix}$	0.021(0.017)	4.40
CDRH125NP-7R5NC	7R5	7.5 $\begin{matrix} +30\% \\ -20\% \end{matrix}$	0.024(0.019)	4.20
CDRH125NP-100MC	100	10 \pm 20%	0.025(0.019)	4.00
CDRH125NP-120MC	120	12 \pm 20%	0.027(0.021)	3.50
CDRH125NP-150MC	150	15 \pm 20%	0.030(0.023)	3.30
CDRH125NP-180MC	180	18 \pm 20%	0.034(0.026)	3.00
CDRH125NP-220MC	220	22 \pm 20%	0.036(0.028)	2.80
CDRH125NP-270MC	270	27 \pm 20%	0.051(0.039)	2.30
CDRH125NP-330MC	330	33 \pm 20%	0.057(0.044)	2.10
CDRH125NP-390MC	390	39 \pm 20%	0.068(0.052)	2.00
CDRH125NP-470MC	470	47 \pm 20%	0.075(0.058)	1.80
CDRH125NP-560MC	560	56 \pm 20%	0.11(0.084)	1.70
CDRH125NP-680MC	680	68 \pm 20%	0.12(0.093)	1.50
CDRH125NP-820MC	820	82 \pm 20%	0.14(0.11)	1.40
CDRH125NP-101MC	101	100 \pm 20%	0.16(0.12)	1.30
CDRH125NP-121MC	121	120 \pm 20%	0.17(0.13)	1.10
CDRH125NP-151MC	151	150 \pm 20%	0.23(0.18)	1.00
CDRH125NP-181MC	181	180 \pm 20%	0.29(0.22)	0.90
CDRH125NP-221MC	221	220 \pm 20%	0.40(0.31)	0.80
CDRH125NP-271MC	271	270 \pm 20%	0.46(0.35)	0.75
CDRH125NP-331MC	331	330 \pm 20%	0.51(0.39)	0.68
CDRH125NP-391MC	391	390 \pm 20%	0.69(0.53)	0.65
CDRH125NP-471MC	471	470 \pm 20%	0.77(0.59)	0.58
CDRH125NP-561MC	561	560 \pm 20%	0.86(0.66)	0.54
CDRH125NP-681MC	681	680 \pm 20%	1.20(0.92)	0.48
CDRH125NP-821MC	821	820 \pm 20%	1.34(1.03)	0.43
CDRH125NP-102MC	102	1000 \pm 20%	1.53(1.18)	0.40

※1. Inductance measuring condition: at 1 kHz.

※2. Rated current: The DC current at which the inductance decreases to 75% of its nominal value or when $\Delta t=40^\circ\text{C}$, whichever is lower.

SMD Power Inductor CDRH125



Saturation Current & Temperature Rise Graph

— L (20°C) — L (100°C) — ΔT

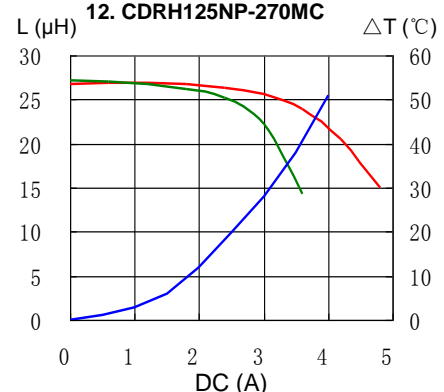
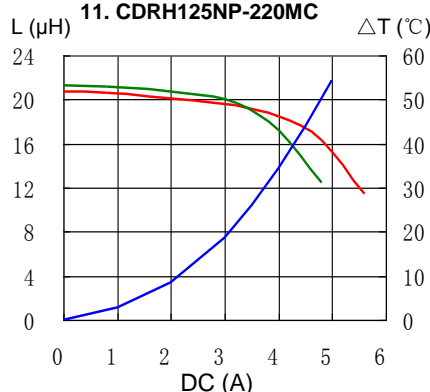
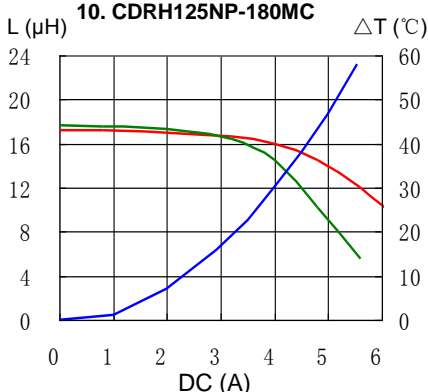
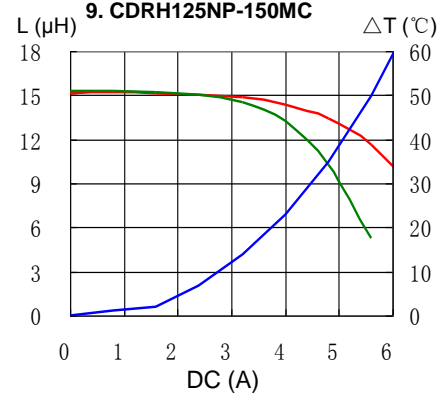
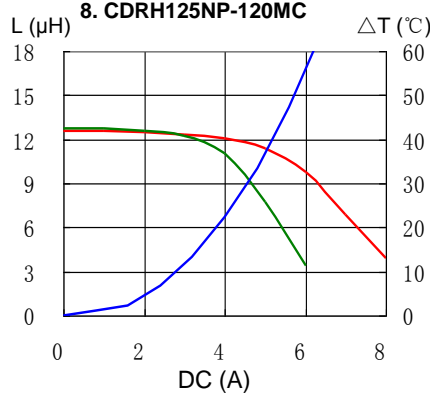
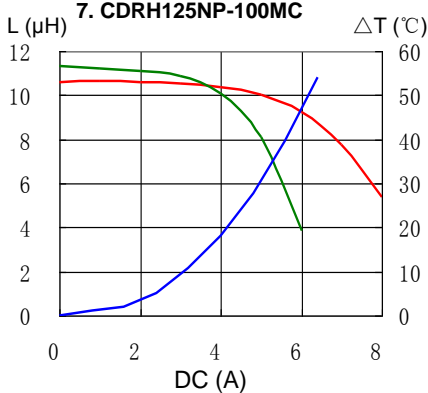
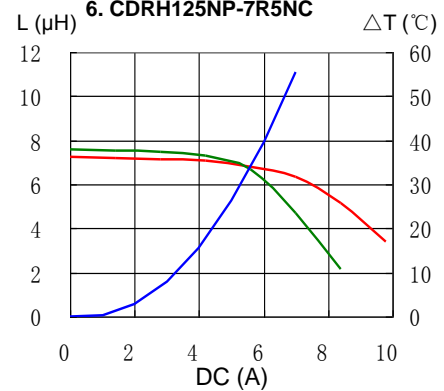
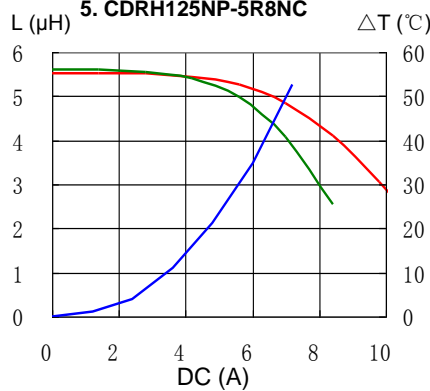
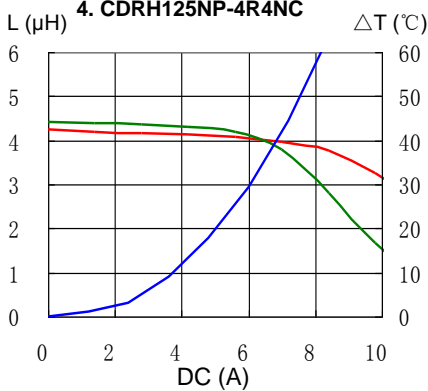
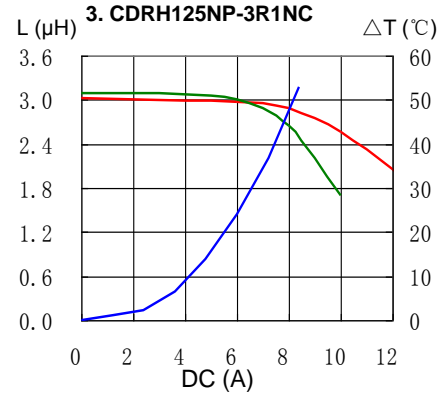
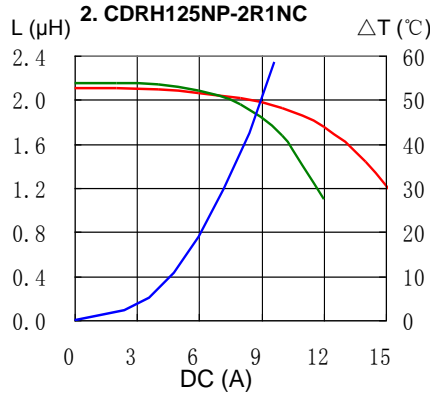
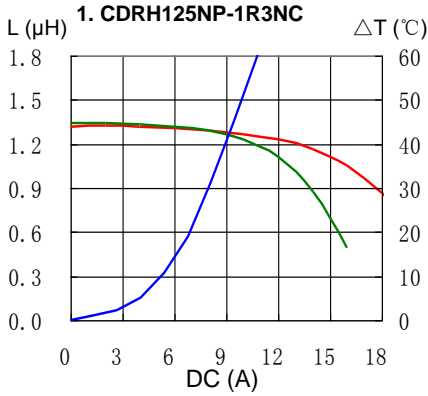

SMD Power Inductor CDRH125



Saturation Current & Temperature Rise Graph

— L (20°C) — L (100°C) — ΔT

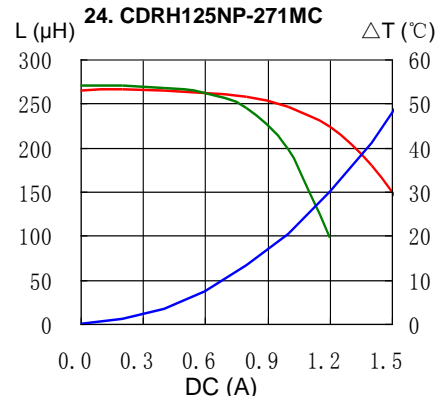
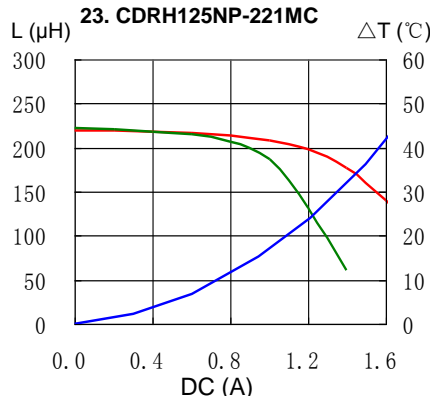
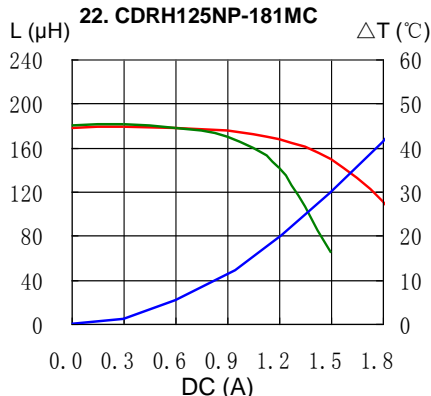
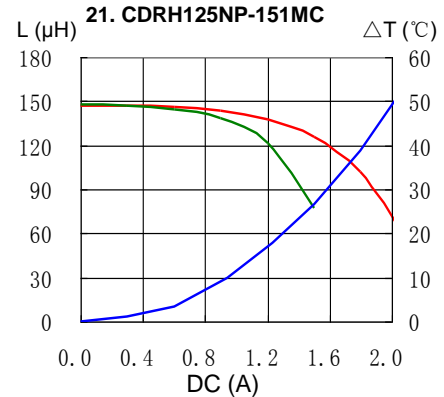
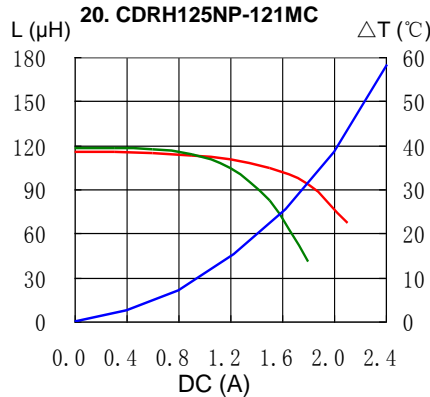
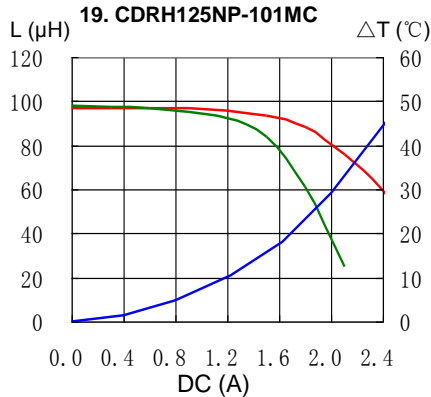
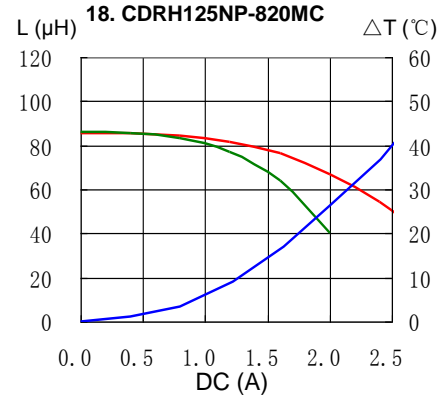
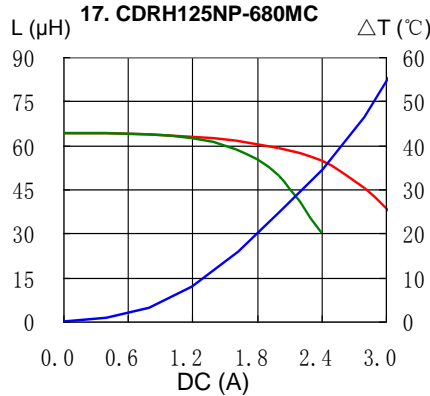
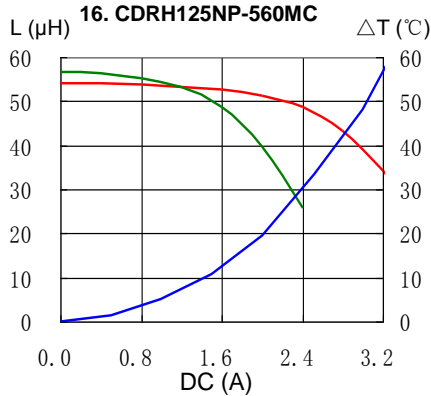
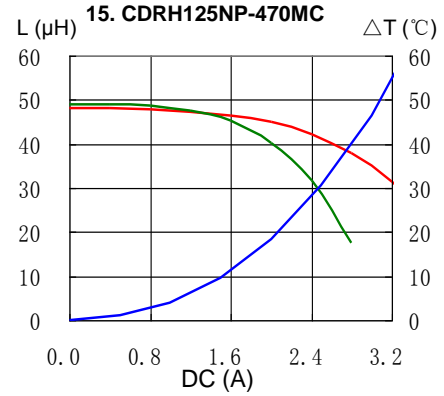
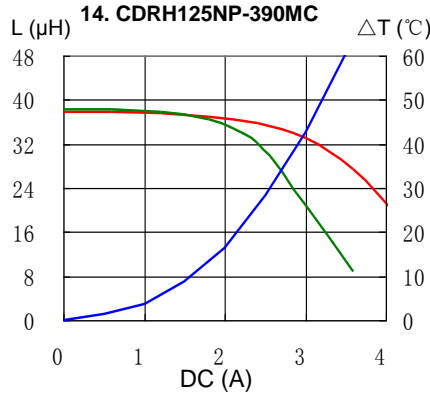
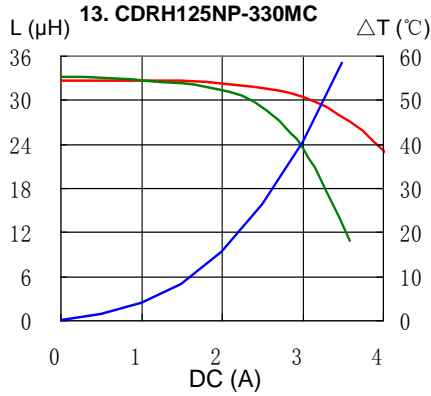

SMD Power Inductor CDRH125

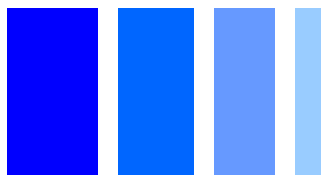

Saturation Current & Temperature Rise Graph

— L (20°C) — L (100°C) — ΔT

25. CDRH125NP-331MC

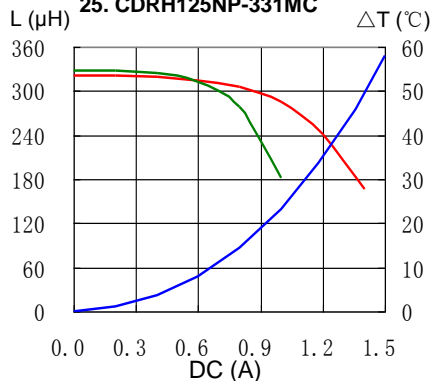

26. CDRH125NP-391MC

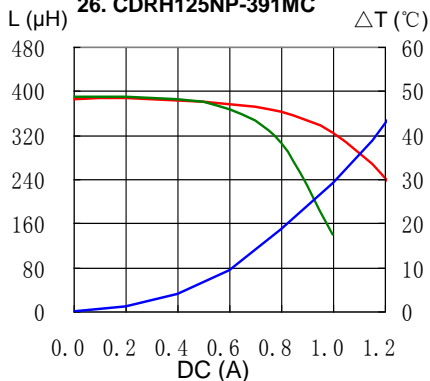

27. CDRH125NP-471MC

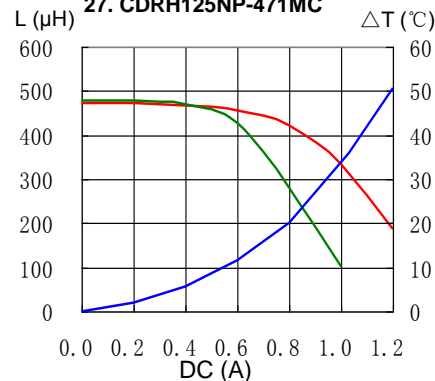

28. CDRH125NP-561MC

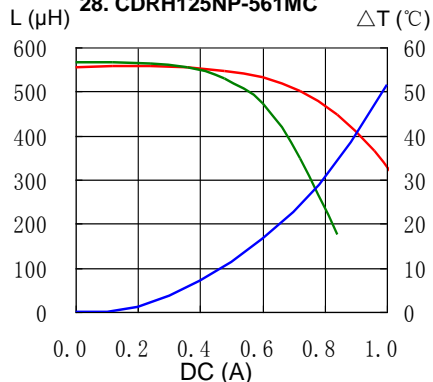

29. CDRH125NP-681MC

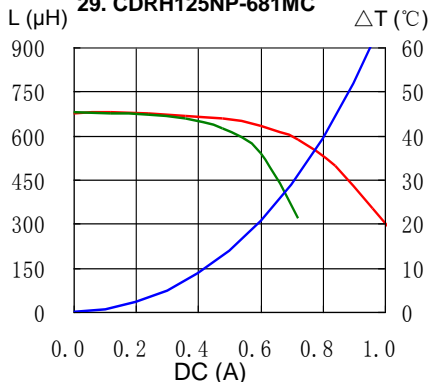

30. CDRH125NP-821MC

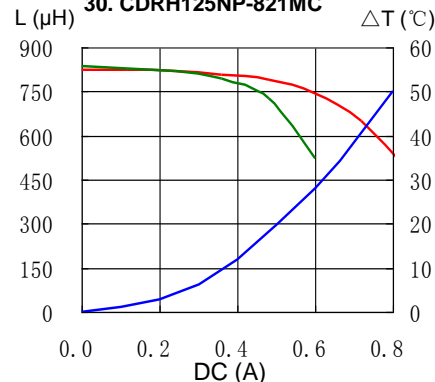

31. CDRH125NP-102MC

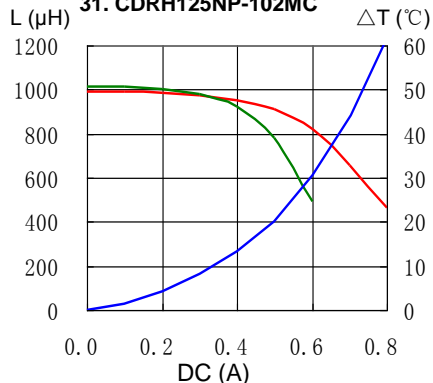

SMD Power Inductor CDRH125



Solder Reflow Condition

Heat Endurance

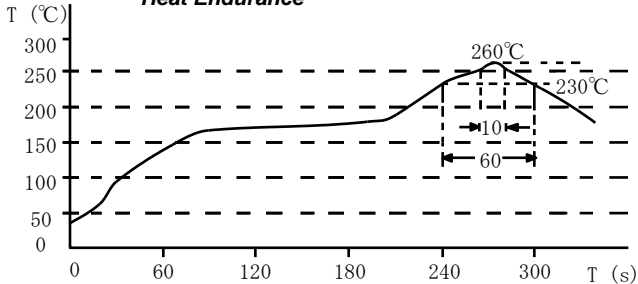

Temperature Chart

